

Apéndice C

DIODO LASER de 1310nm

Hoja 1 de 5

	NEC's 1310 nm InGaAsP MQW-DFB LASER DIODE IN COAXIAL PACKAGE FOR FIBER OPTIC COMMUNICATIONS	NX8304BE-CC NX8304CE-CC
-----------------------------------------------------------------------------------	----------------------------------------------------------------------------------------------------------------	------------------------------------

FEATURES

- **INTERNAL OPTICAL ISOLATOR**
- **PEAK EMISSION WAVELENGTH:**
 $\lambda_p = 1310 \text{ nm}$
- **OPTICAL OUTPUT POWER:**
 $P_r = 2.0 \text{ mW}$
- **WIDE OPERATING TEMPERATURE RANGE:**
 $T_c = -40 \text{ to } +85^\circ\text{C}$
- **InGaAs MONITOR PIN-PD**
- **WITH SC-UPC CONNECTOR**
- **BASED ON TELCORDIA RELIABILITY**

DESCRIPTION

NEC's NX8304BE-CC and NX8304CE-CC are 1310 nm Distributed Feed-Back (DFB) laser diode coaxial modules with an internal optical isolator. These modules are light source for fiber optic communications.

ELECTRO-OPTICAL CHARACTERISTICS ($T_c = -40 \text{ to } +85^\circ\text{C}$, unless otherwise specified)

PART NUMBER			NX8304BE-CC, NX8304CE-CC		
SYMBOLS	PARAMETERS AND CONDITIONS	UNITS	MIN	TYP	MAX
P_r	Optical Output Power from Fiber, CW	mW		2.0	
V_{OP}	Operating Voltage, $P_r = 2.0 \text{ mW}$	V		1.2	1.6
I_{TH}	Threshold Current	$T_c = +25^\circ\text{C}$	mA	15	25
					55
P_{TH}	Threshold Output Power, $I_F = I_{TH}$	μW			100
I_{MOD}	Modulation Current	$P_r = 2.0 \text{ mW}$, $T_c = 25^\circ\text{C}$	mA	8	30
		$P_r = 2.0 \text{ mW}$	mA	6	50
η_d	Differential Efficiency	$P_r = 2.0 \text{ mW}$, $T_c = 25^\circ\text{C}$	W/A	0.07	0.100
		$P_r = 2.0 \text{ mW}$	W/A	0.040	0.300
$\Delta\eta_d$	Temperature Dependence of Differential Efficiency, $\Delta\eta_d = 10 \log \frac{\eta_d (@ T_c \text{ } ^\circ\text{C})}{\eta_d (@ 25 \text{ } ^\circ\text{C})}$	dB	-3.5	-2.2	
Kink	Kink, $P_r = \text{Up to } 2.4 \text{ mW}$ (Refer to defenitions)	%			± 20
λ_p	Peak Emission Wavelength, $P_r = 2.0 \text{ mW}$	nm	1280	1310	1335
$\Delta\lambda/\Delta T$	Temperature Dependence of Peak Emission Wavelength	nm/ $^\circ\text{C}$		0.09	0.1
$\Delta\lambda$	Spectral Width, $P_r = 2.0 \text{ mW}$, -20 dB down width	nm		0.1	1.0
SMSR	Side Mode Suppression Ratio, $P_r = 2.0 \text{ mW}$	dB	30	40	
f_c	Cut-Off Frequency, $P_r = 2.0 \text{ mW}$	GHz		2.0	
t_r	Rise Time, 10 to 90%, $P_{pk} = 2.0 \text{ mW}$, $I_F = I_{TH}$	ns		0.15	0.5
t_f	Fall Time, 90 to 10%, $P_{pk} = 2.0 \text{ mW}$, $I_F = I_{TH}$	ns		0.15	0.5
I_m	Monitor Current, $V_R = 5 \text{ V}$, $P_r = 2.0 \text{ mW}$	μA	200	700	1500
I_D	Monitor Dark Current	$V_R = 5 \text{ V}$, $T_c = 25^\circ\text{C}$	nA	0.1	50
		$V_R = 5 \text{ V}$	nA	10	500
C_t	Monitor PD Terminal Capacitance, $V_R = 5 \text{ V}$, $f = 1 \text{ MHz}$	pF		1.0	20
LIN_m	Linearity, $V_R = 5 \text{ V}$, $P_r = 0.2 \text{ to } 2.0 \text{ mW}$ (Refer to defenitions)	%			15
γ^1	Tracking Error, $I_m = \text{const.}$ (Refer to defenitions)	dB		0.5	1.0
RIN	Relative Intensity Noise	dB/Hz		-135	
ORL	Optical Return Loss, SMF	dB	35	52	

California Eastern Laboratories

NX8304BE-CC, NX8304CE-CC

ABSOLUTE MAXIMUM RATINGS¹

(Tc = 25°C, unless otherwise specified)

SYMBOLS	PARAMETERS	UNITS	RATINGS
Pf	Optical Output Power from Fiber	mW	5
If	Forward Current of LD	mA	150
VR	Reverse Voltage of LD	V	2.0
If	Forward Current of PD	mA	2.0
VR	Reverse Voltage of PD	V	15
Tc	Operating Case Temperature	°C	-40 to +85
TSTG	Storage Temperature	°C	-40 to +85
TSLD	Lead Soldering Temperature (3 s)	°C	350
RH	Relative Humidity (noncondensing)	%	85

Note:

1. Operation in excess of any one of these parameters may result in permanent damage.

PARAMETER DEFINITIONS

Kink : kink

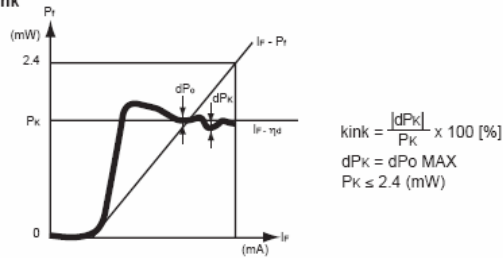

Linearity : LINm

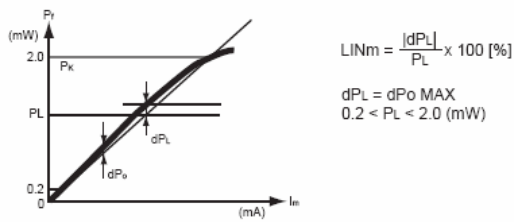

Tracking Error : γ

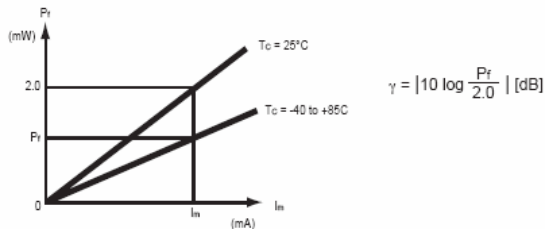

NX8304BE-CC, NX8304CE-CC

TYPICAL PERFORMANCE CURVES ($T_c = 25^\circ\text{C}$ unless otherwise specified)

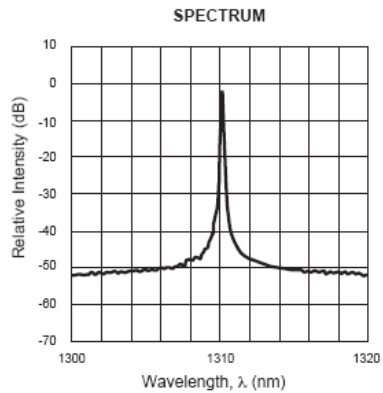
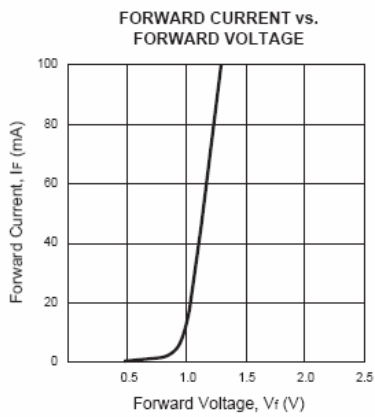
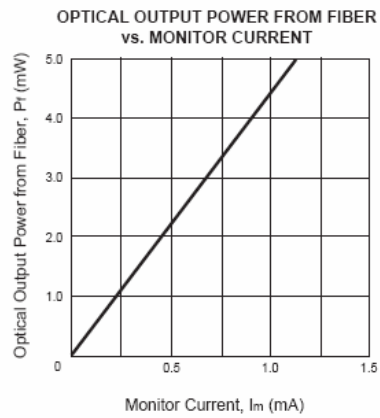
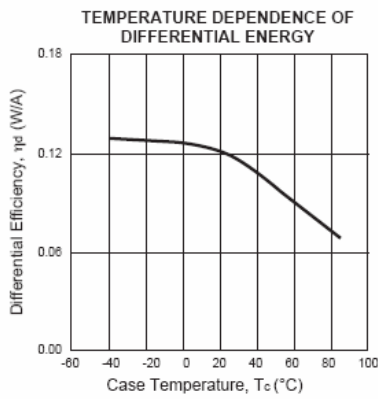
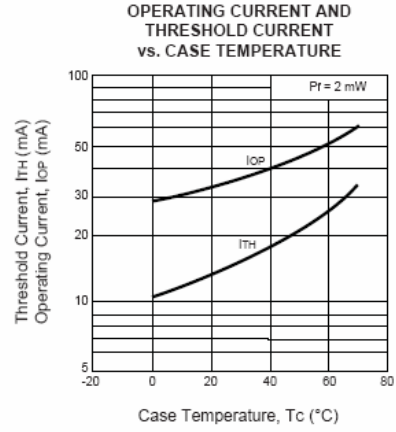
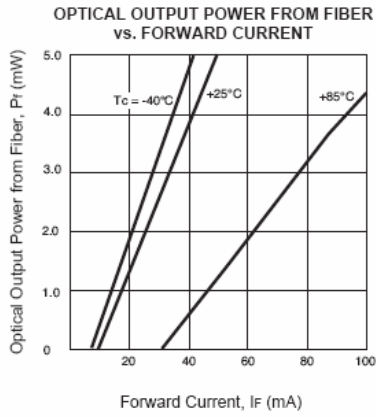

NX8304BE-CC, NX8304CE-CC

TYPICAL PERFORMANCE CURVES ($T_c = 25^\circ\text{C}$ unless otherwise specified)

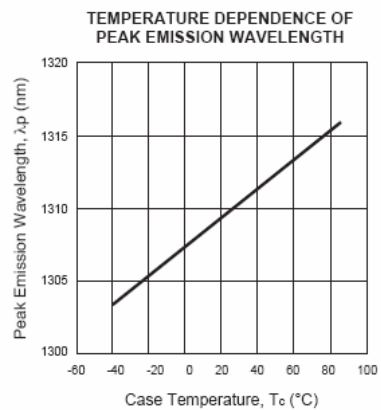

NX8304BE-CC, NX8304CE-CC

OUTLINE DIMENSIONS (Units in mm)

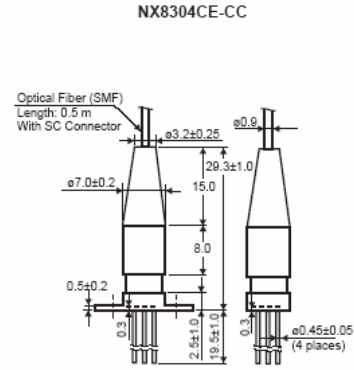
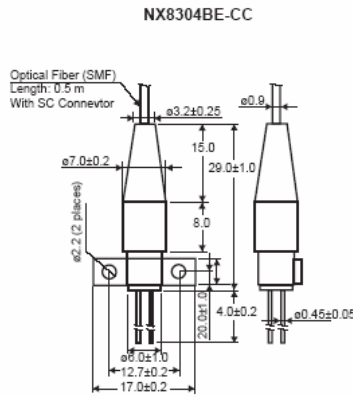

PIN CONNECTIONS

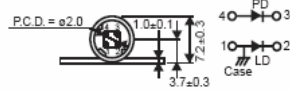

PIN CONNECTIONS

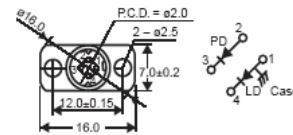

OPTICAL FIBER CHARACTERISTICS

PARAMETER	UNITS	SPECIFICATION
Mode Field Diameter	μm	9.5±1
Cladding Diameter	μm	125±2
Maximum Cladding Noncircularity	%	2
Maximum Core/Cladding Concentricity	%	1.6
Outer Diameter	mm	0.9±0.1
Cut-off Wavelength	nm	1100 to 1270
Minimum Fiber Bending Radius	mm	30
Fiber Length	mm	500±50
Flammability		UL 1581 VW-1

ORDERING INFORMATION

PART NUMBER	AVAILABLE CONNECTOR	FLANGE TYPE
NX8304BE-CC	With SC-UPC Connector	Flat Mount Flange
NX8304CE-CC		Vertical Mount Flange

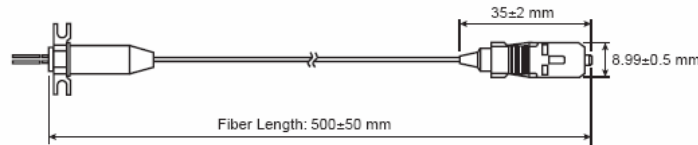

Life Support Applications

These NEC products are not intended for use in life support devices, appliances, or systems where the malfunction of these products can reasonably be expected to result in personal injury. The customers of CEL using or selling these products for use in such applications do so at their own risk and agree to fully indemnify CEL for all damages resulting from such improper use or sale.

CEL California Eastern Laboratories, Your source for NEC RF, Microwave, Optoelectronic, and Fiber Optic Semiconductor Devices.
4590 Patrick Henry Drive • Santa Clara, CA 95054-1817 • (408) 988-3500 • FAX (408) 988-0279 • www.cel.com

DATA SUBJECT TO CHANGE WITHOUT NOTICE

03/03/2003

NEC
A Business Partner of NEC Component Semiconductor Devices, Ltd.