

I-orill

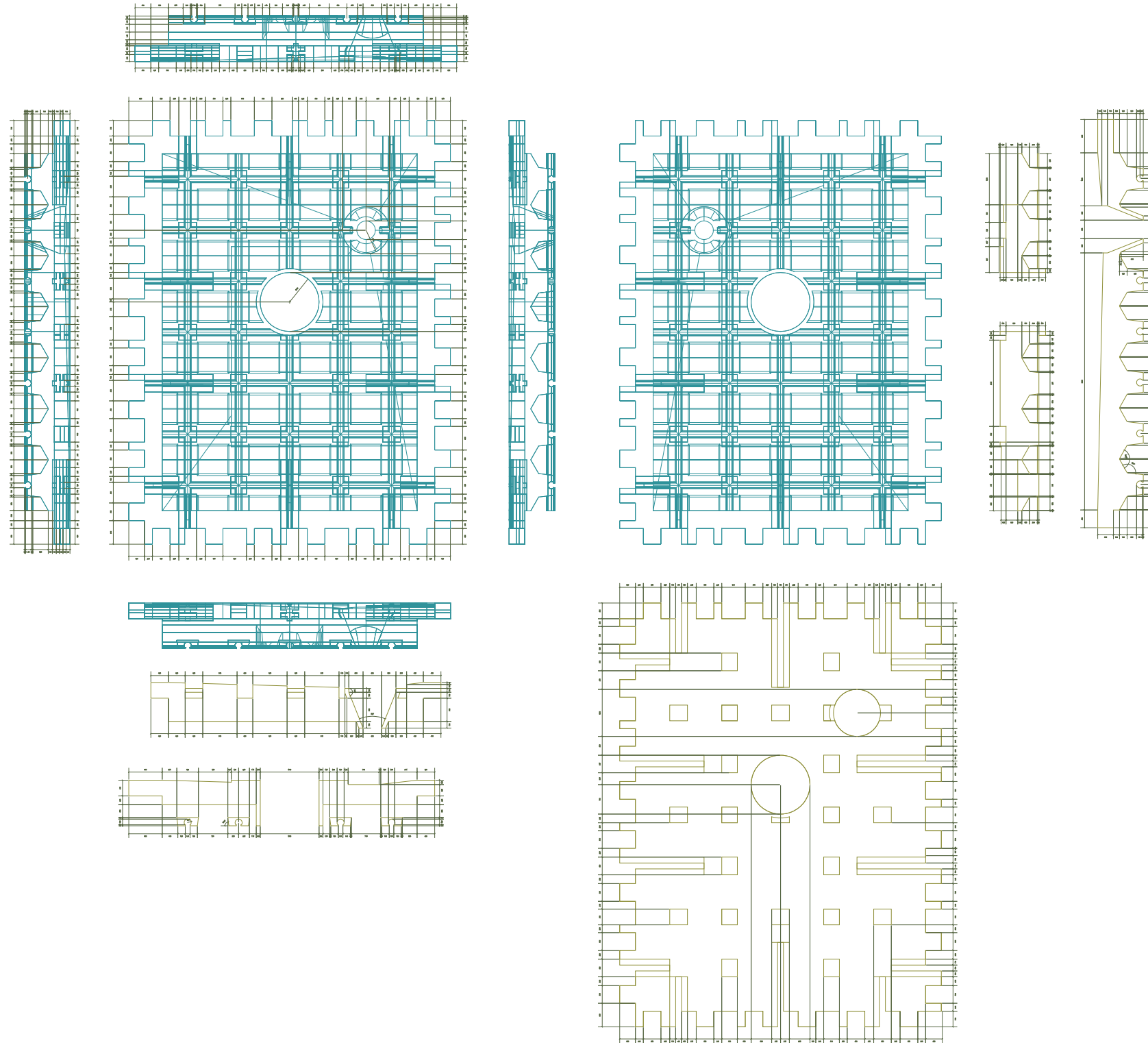

I-bano

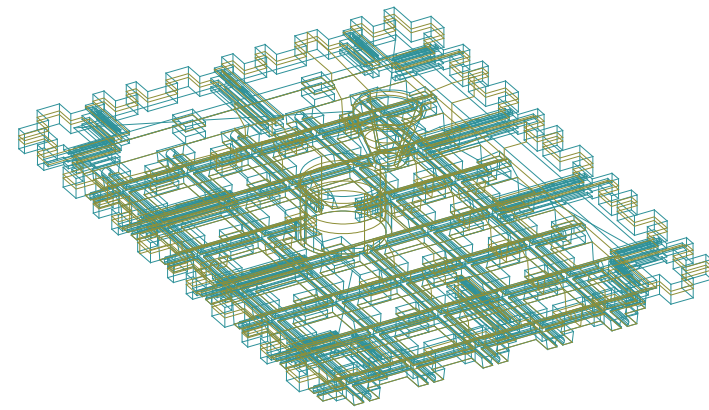
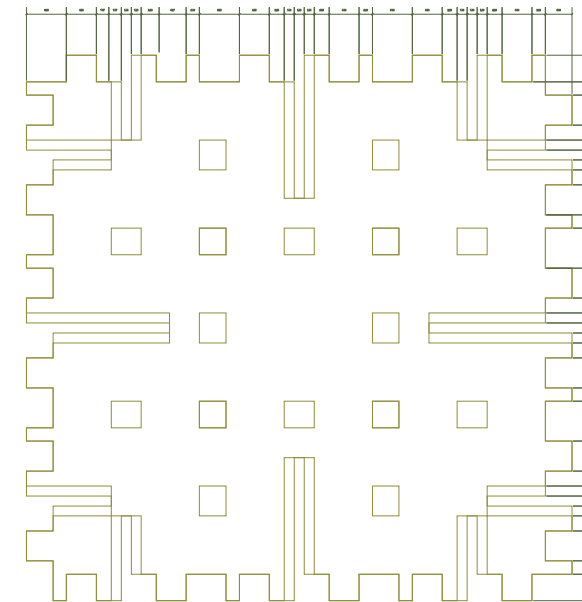
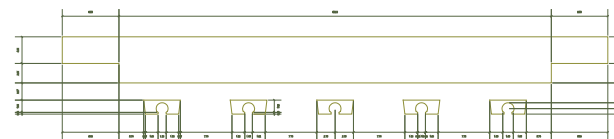
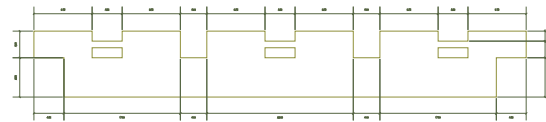
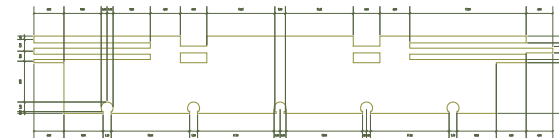
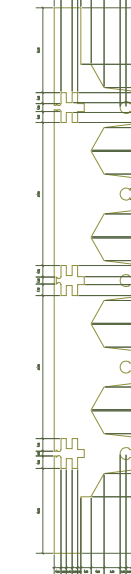
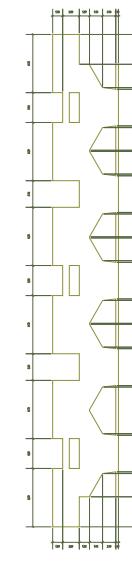
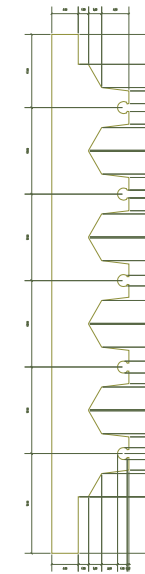
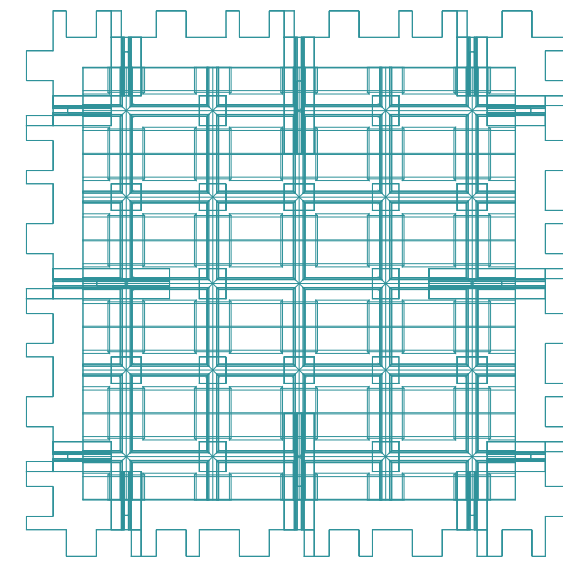
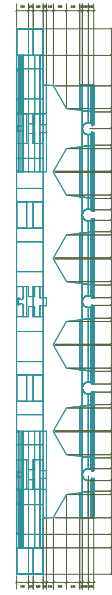
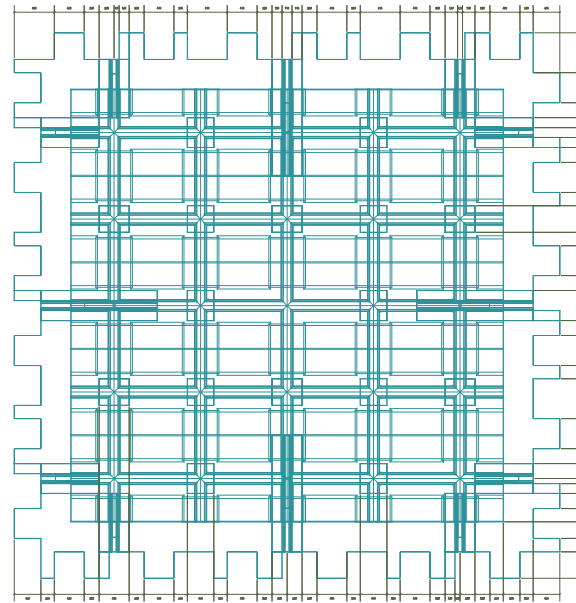
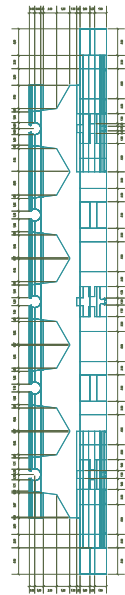
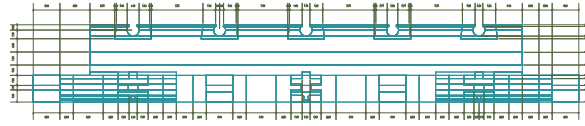
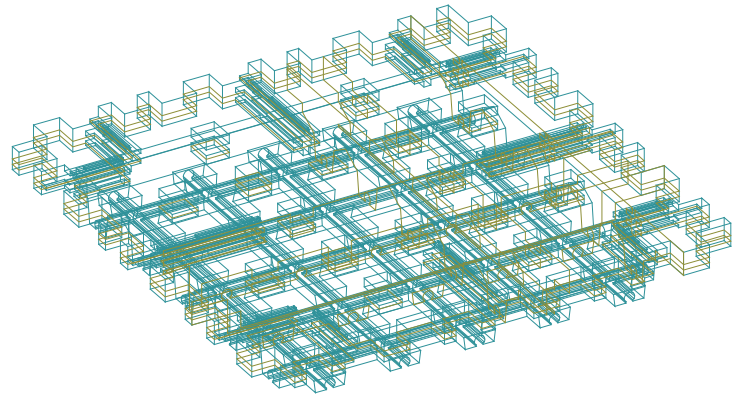

I-inter

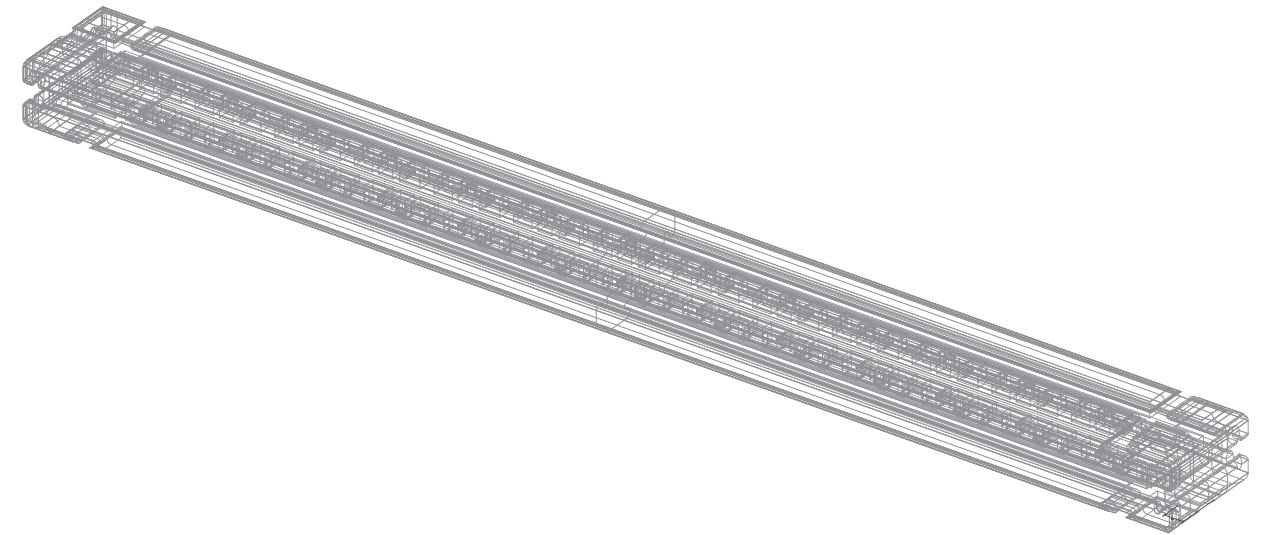
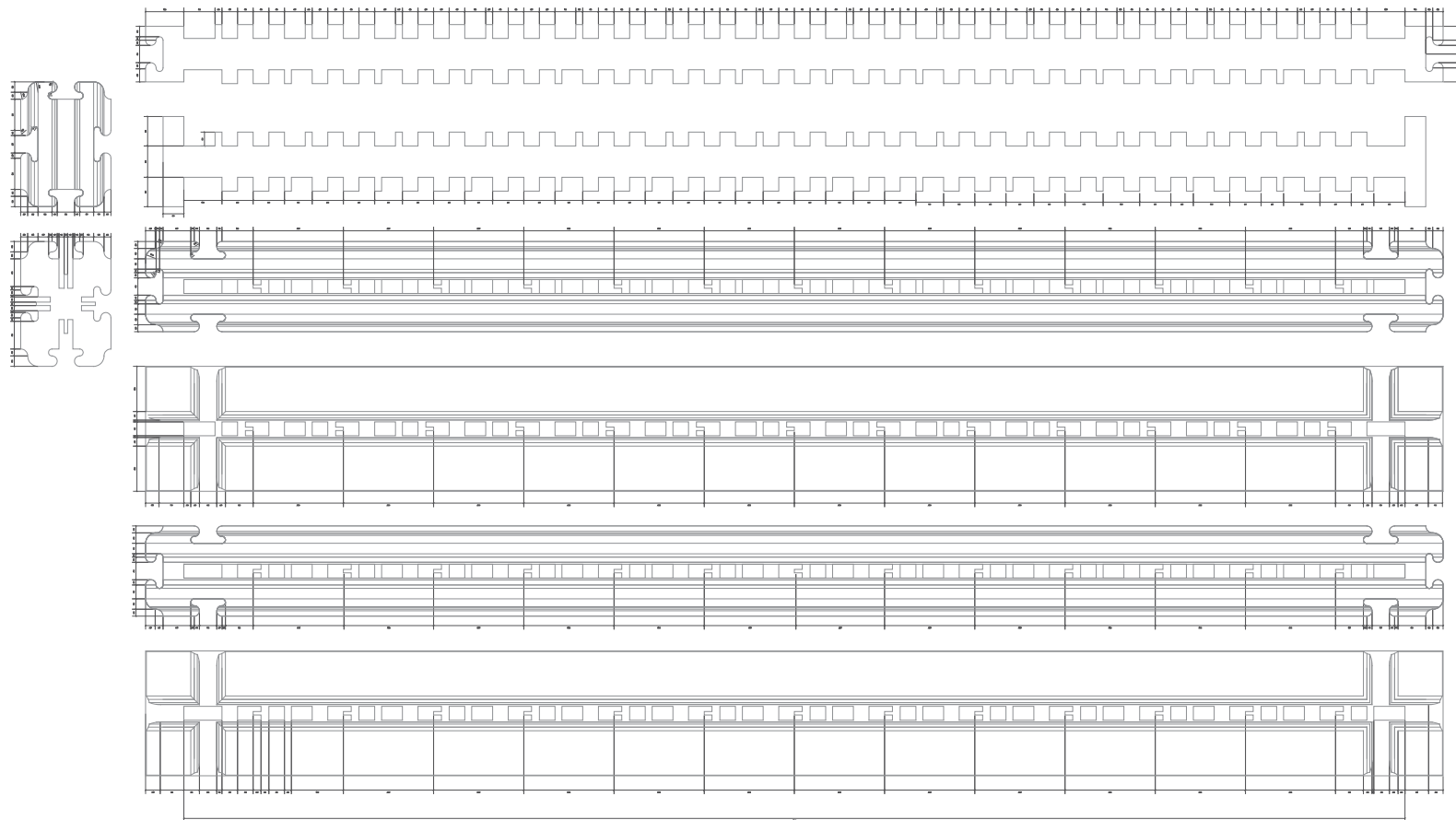

e-trab1

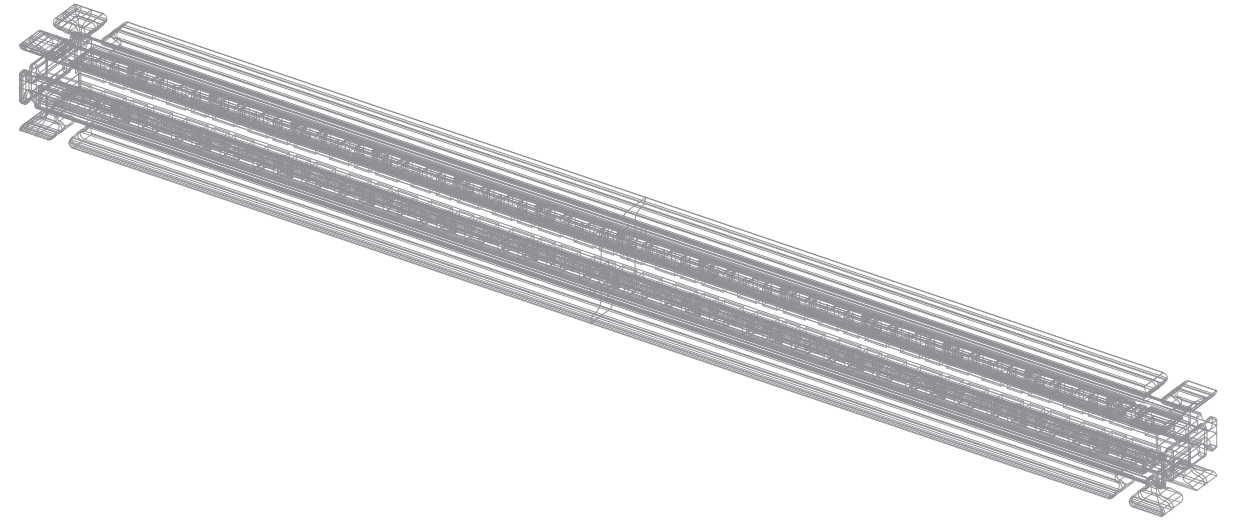
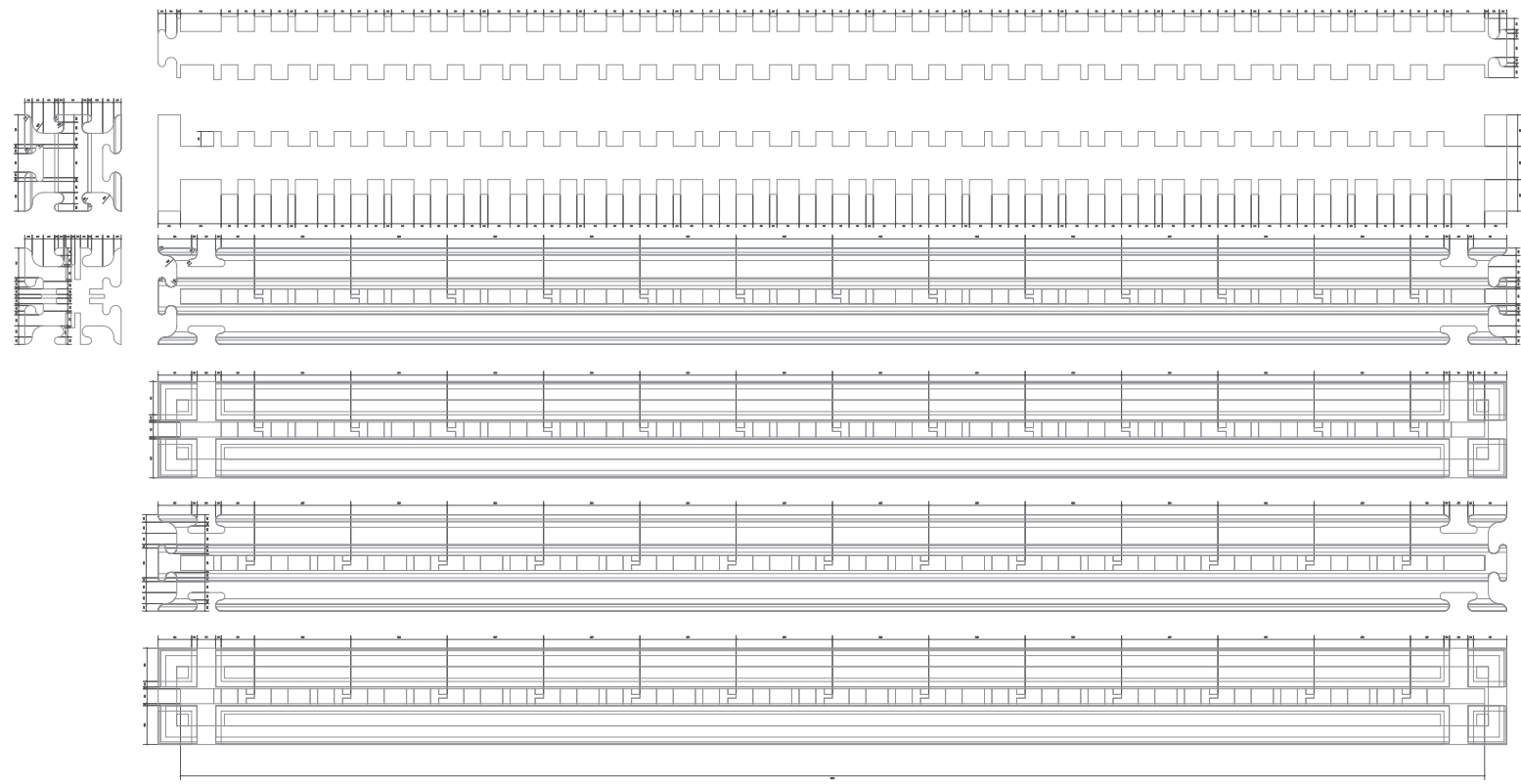

e-trab2

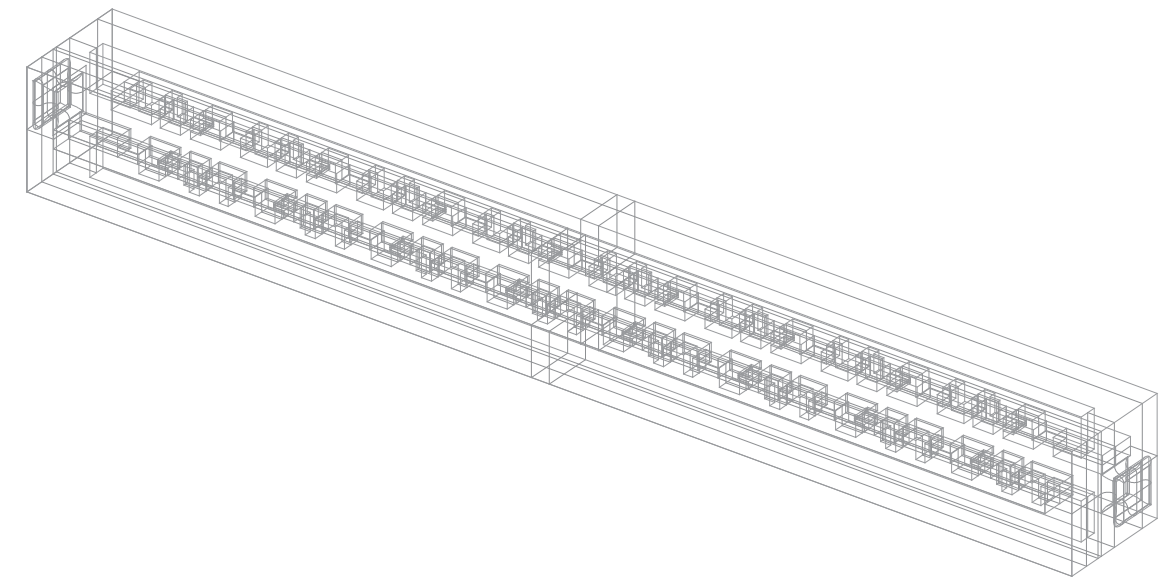
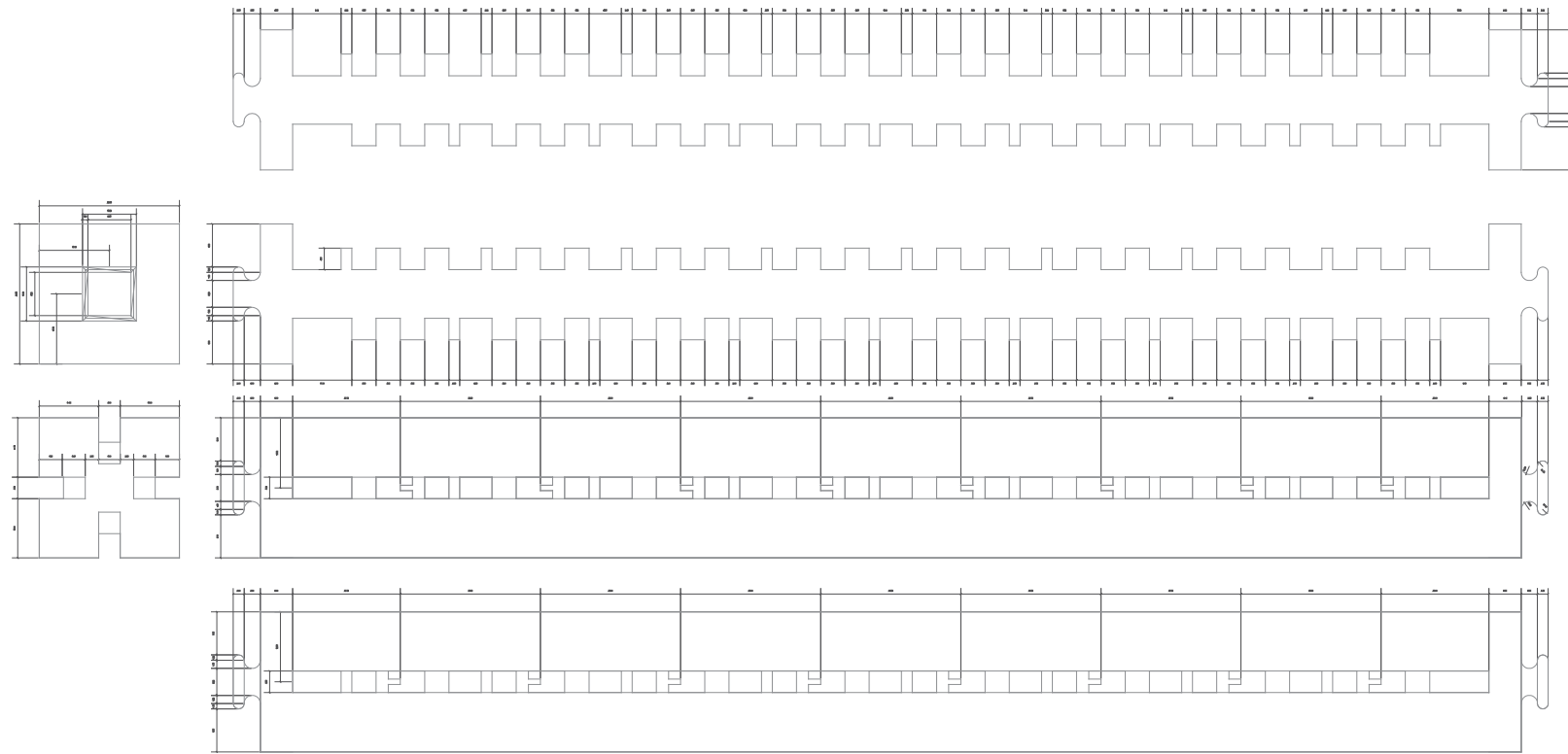

e-colum

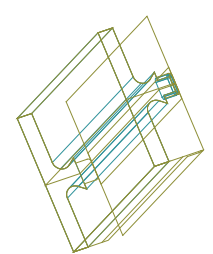
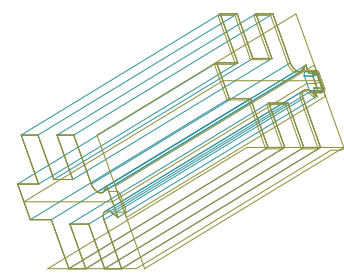
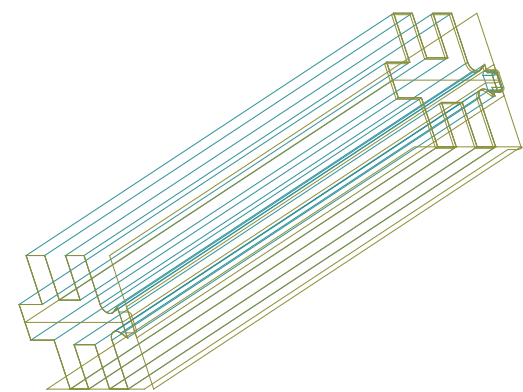
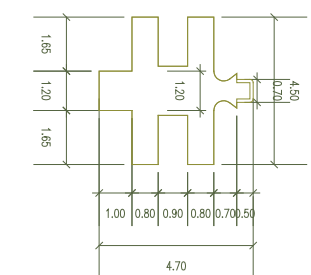
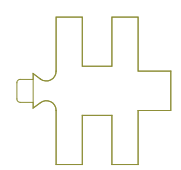
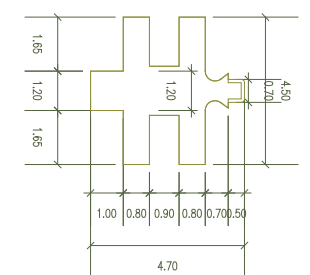
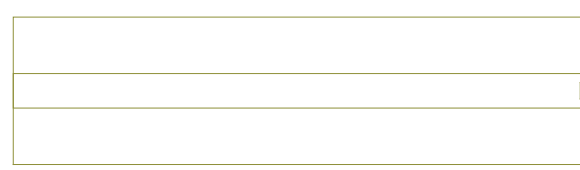
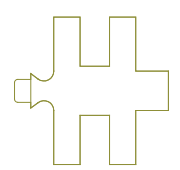
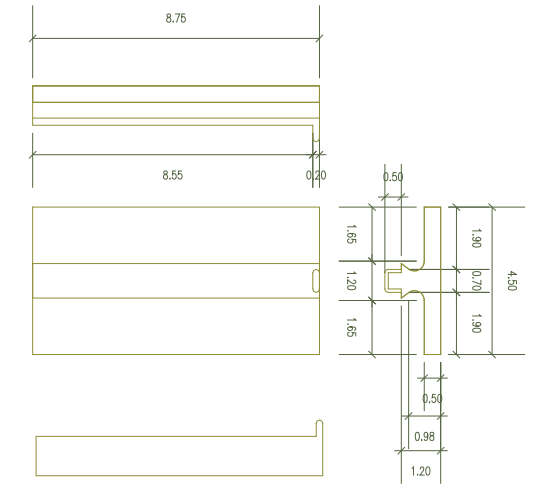
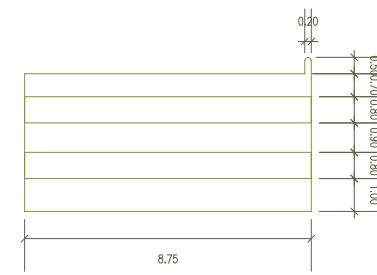
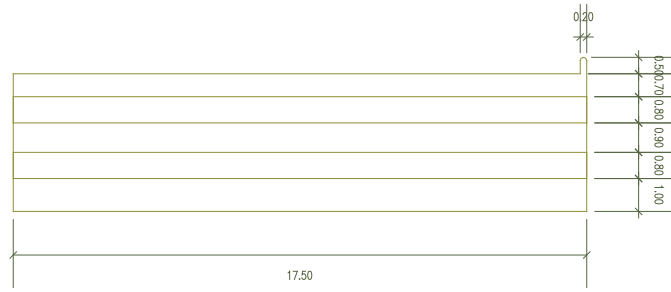

co-L met

co-P met

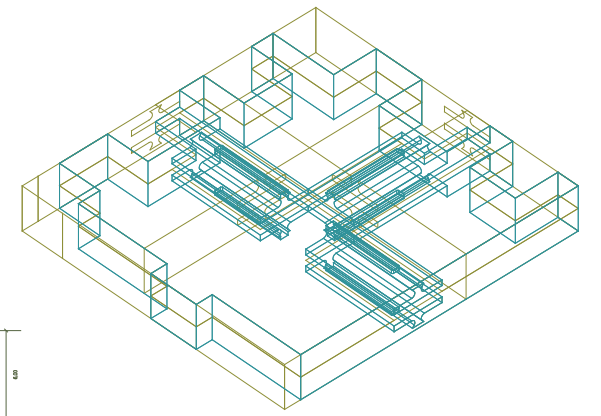
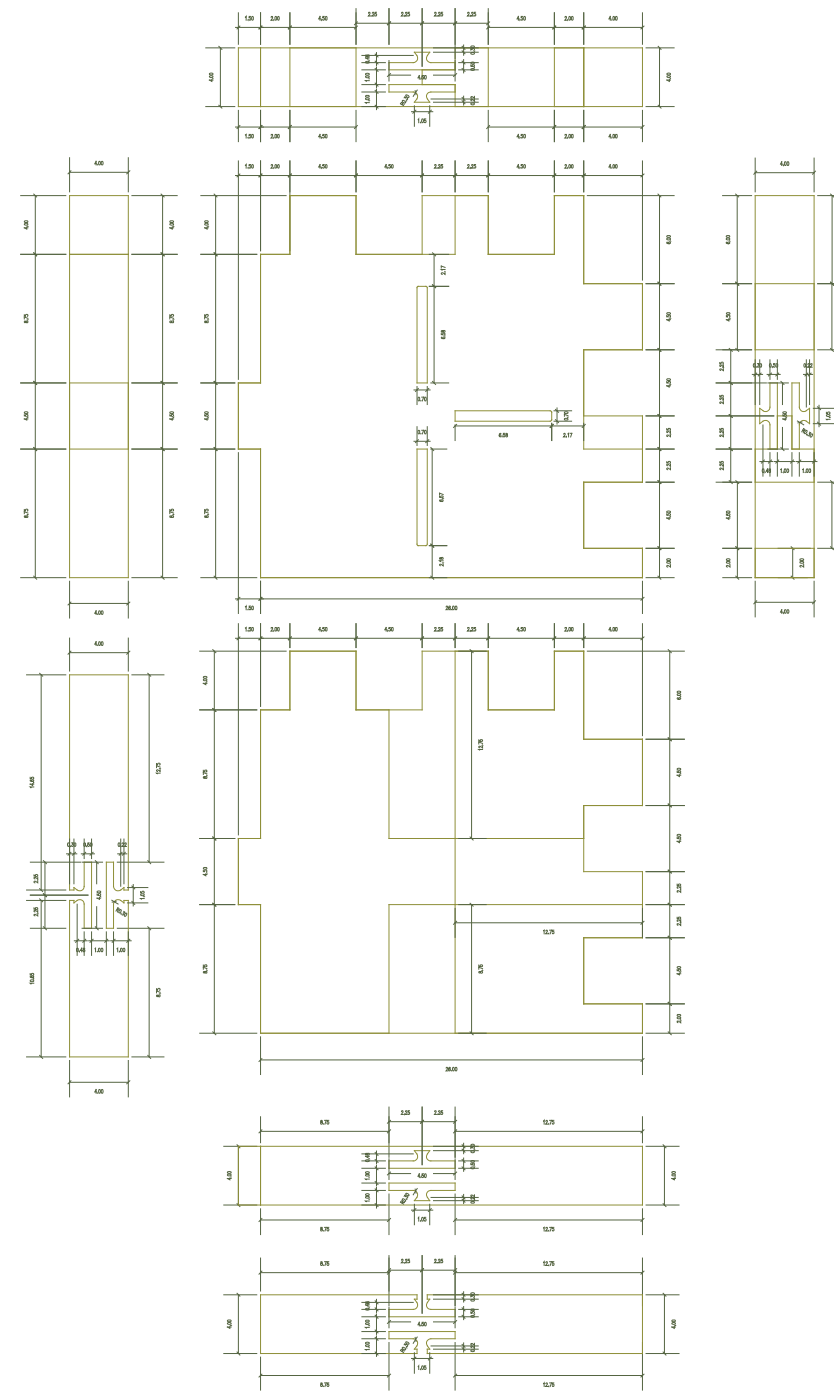
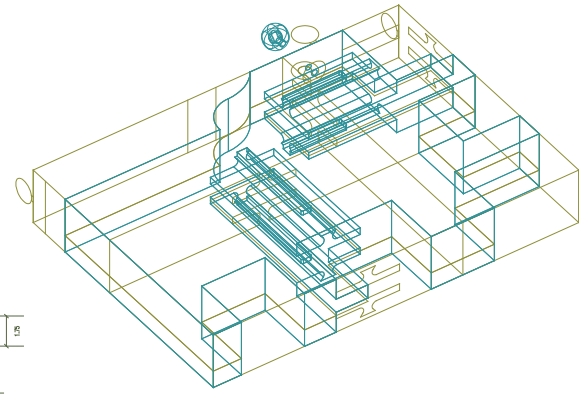
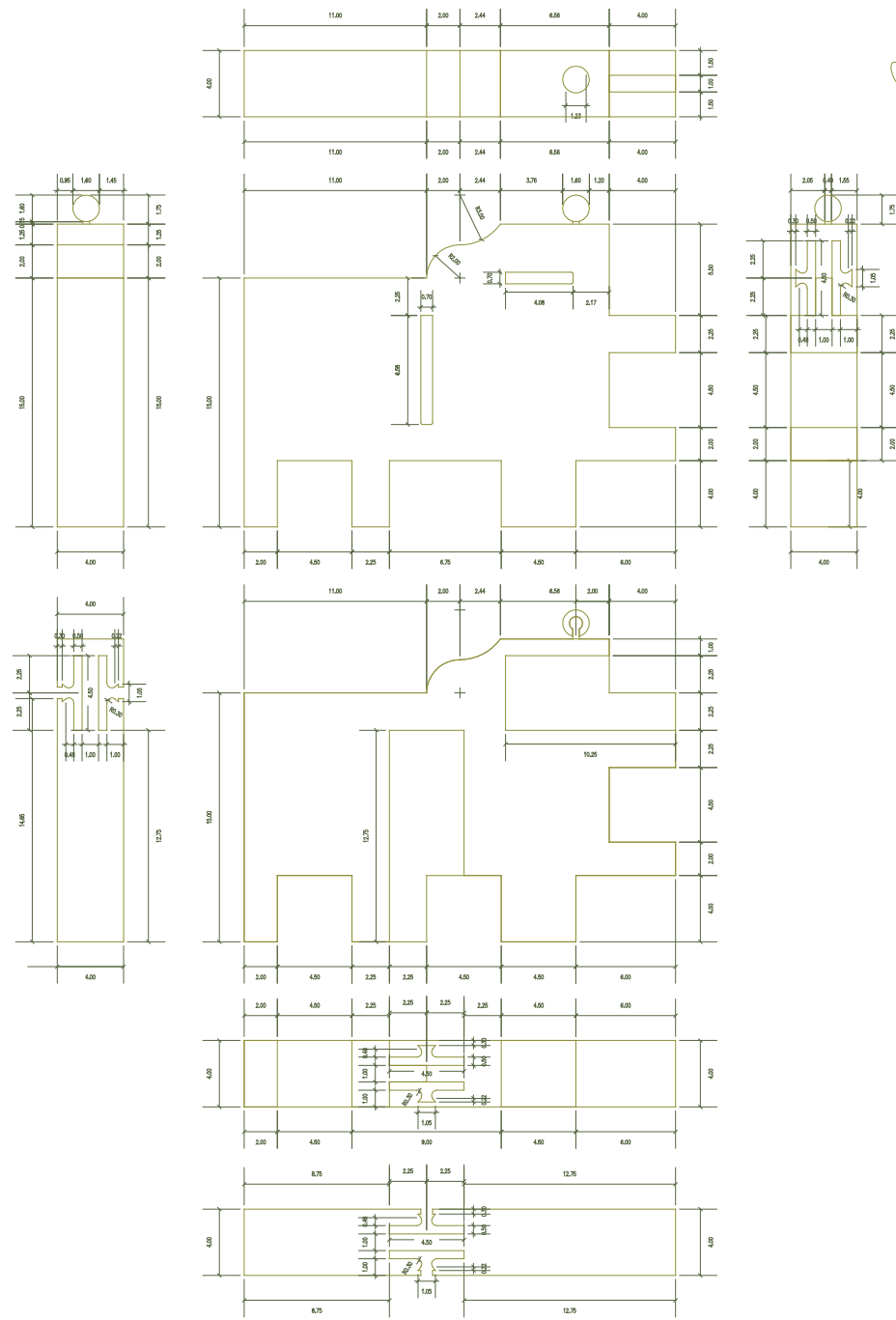

p-CLPE2 izq

p-CPLP der



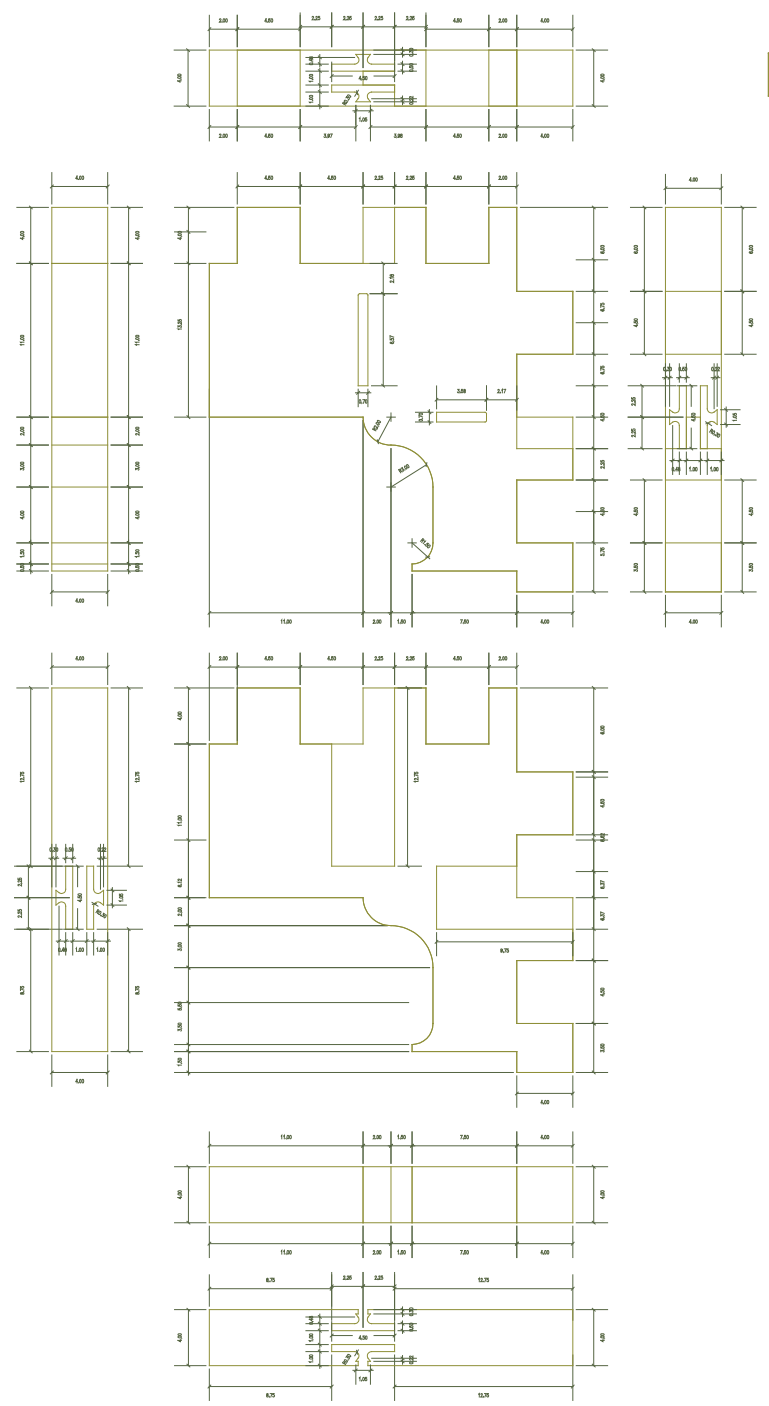

p-CEP2 der

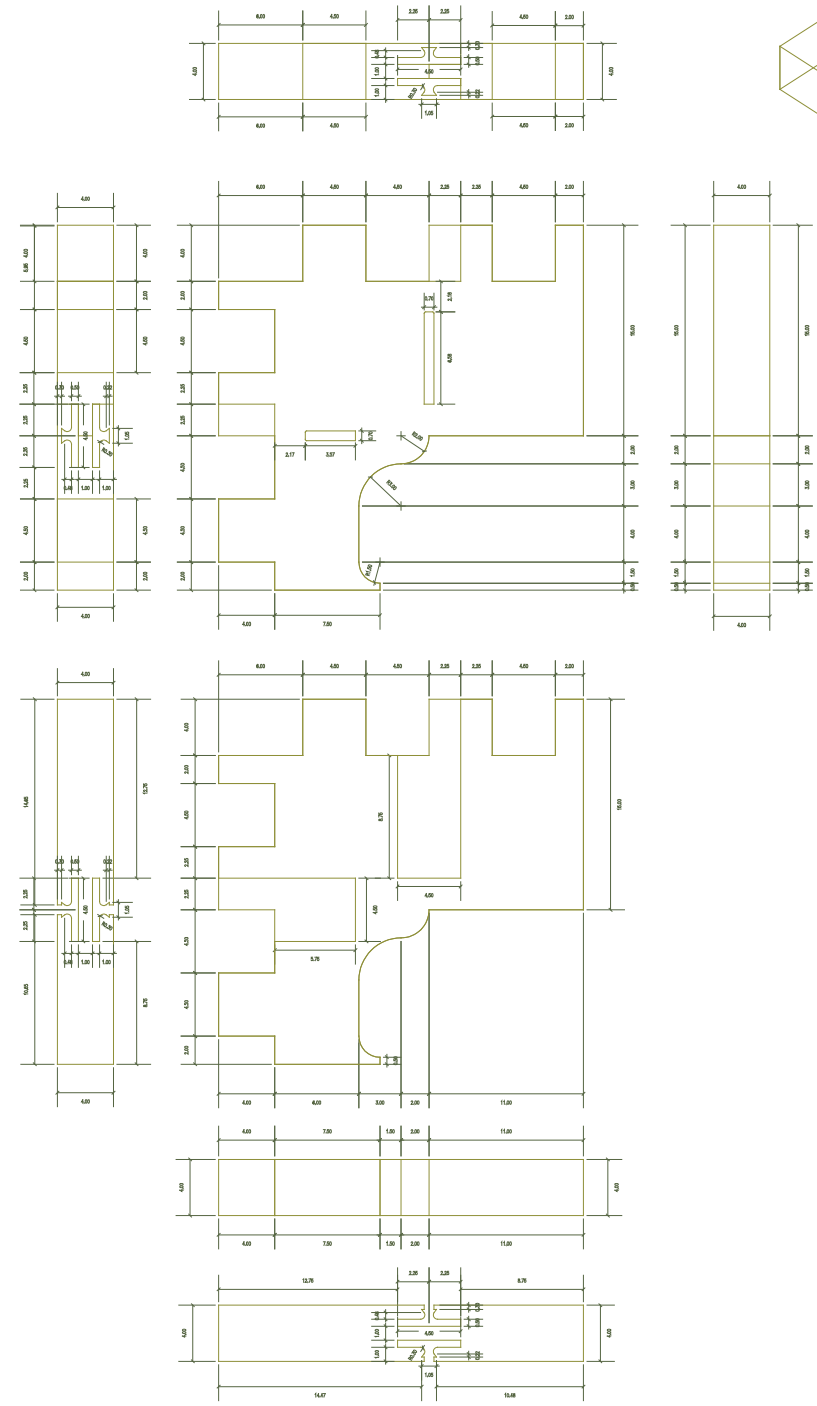
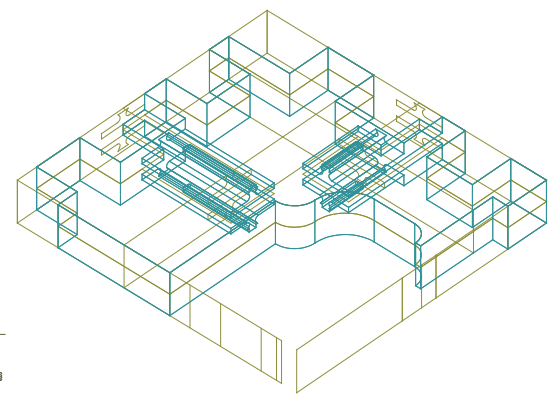

p-CEP2 izq

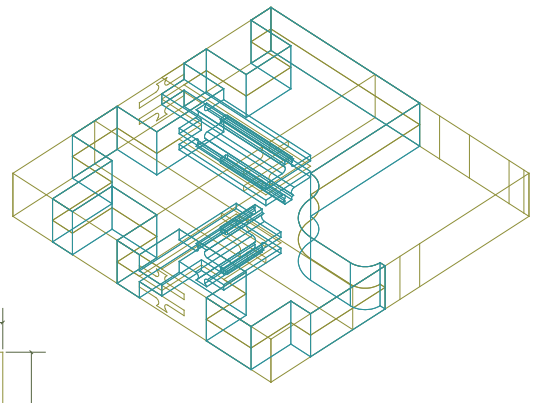



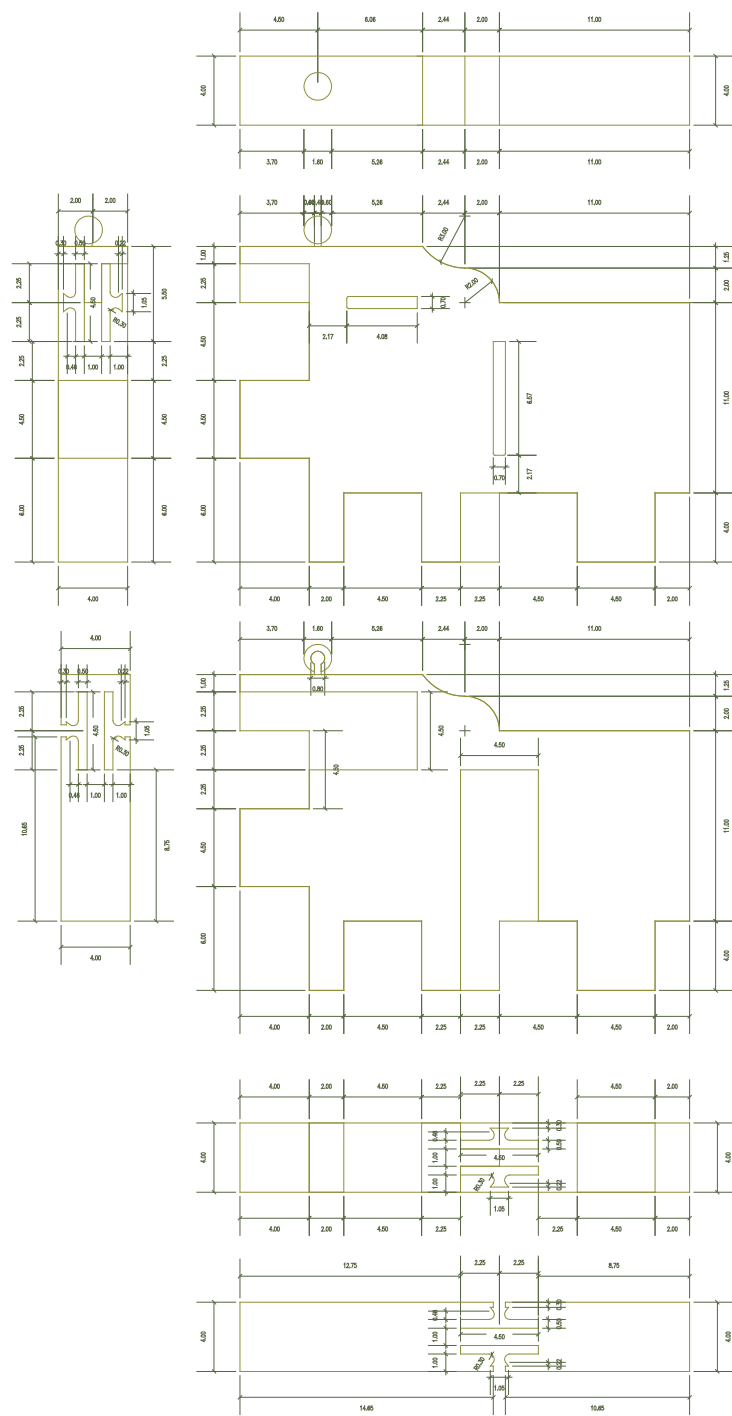

p-CLPE2 der

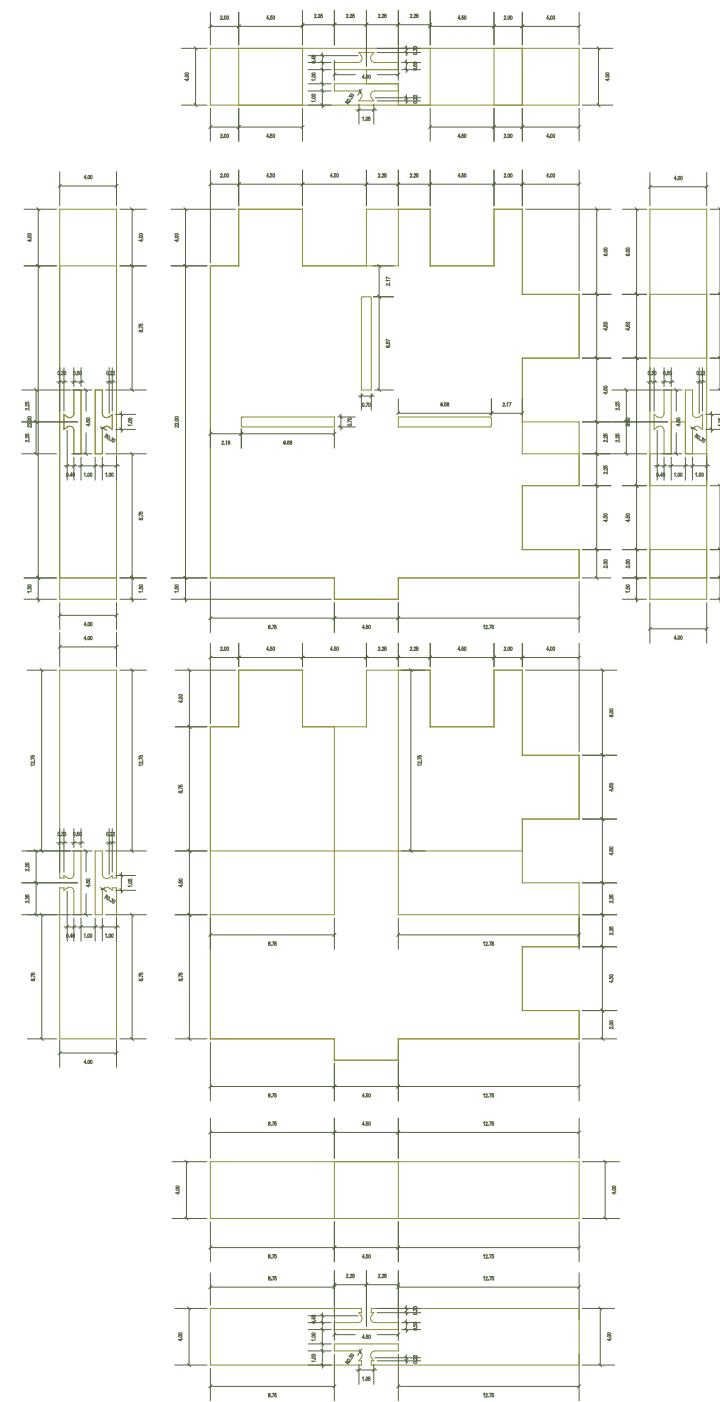
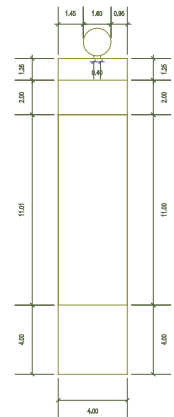
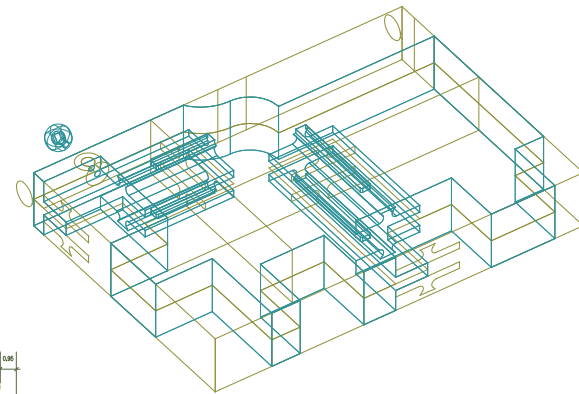

p-CPLP1 izq

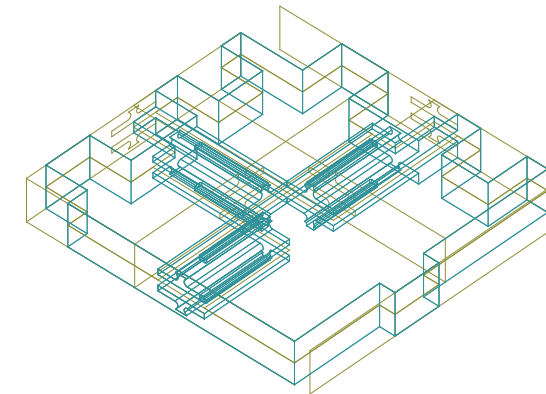

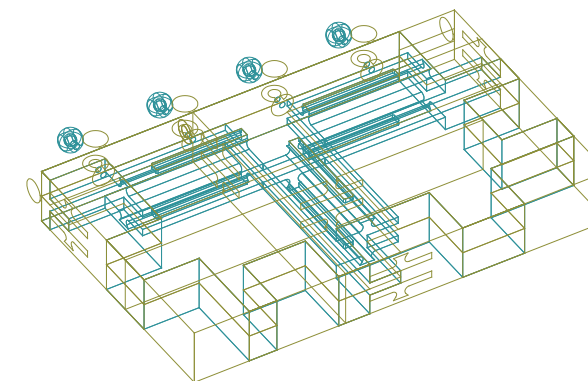
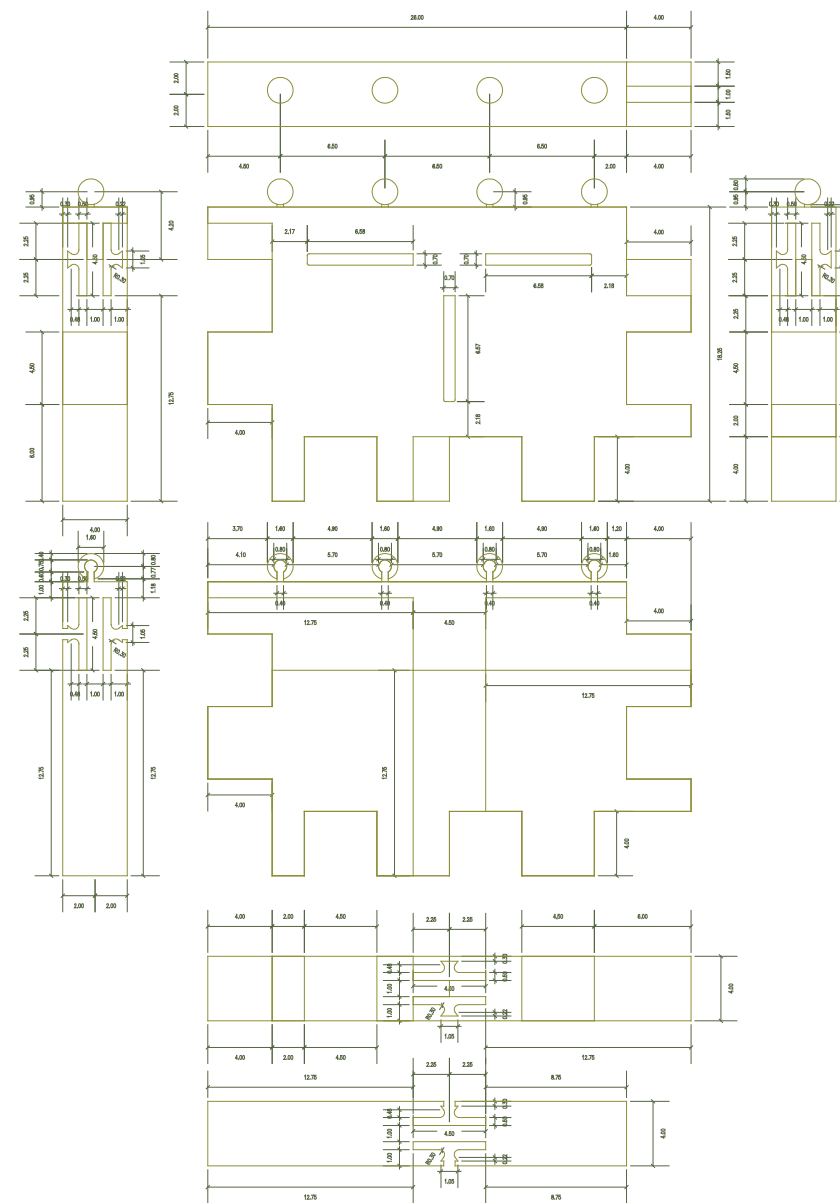
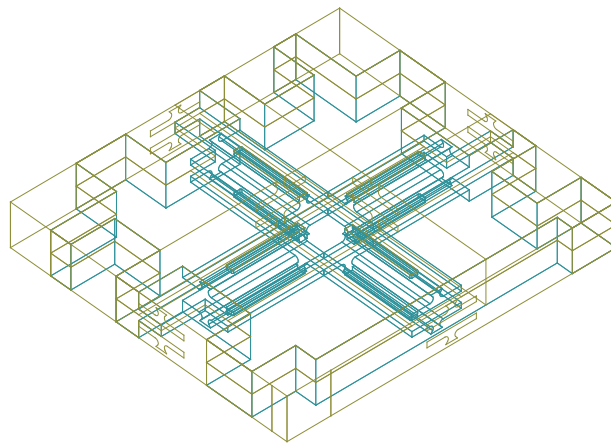
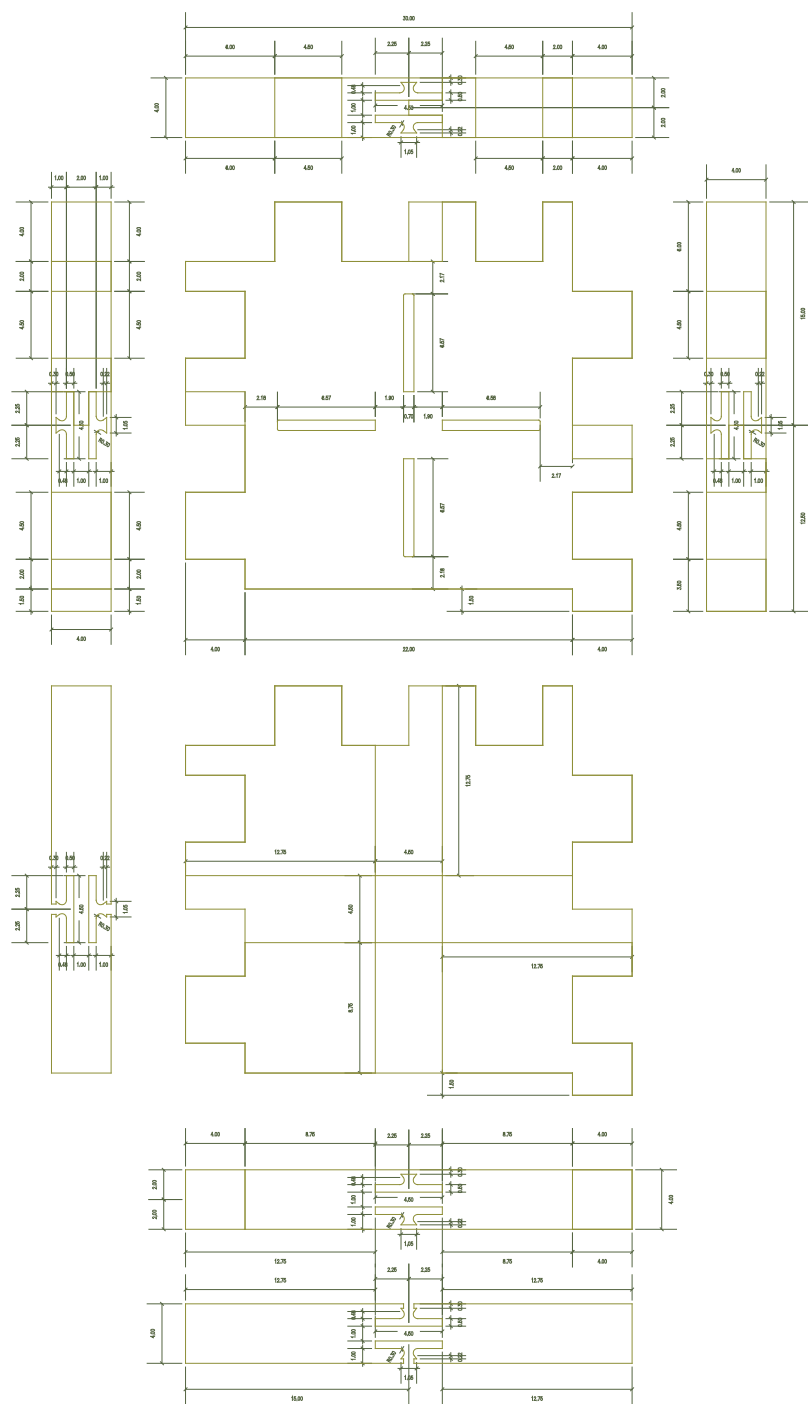

p-CEPLP inter

p-CPLP mov



